

**MAL209616821E3**

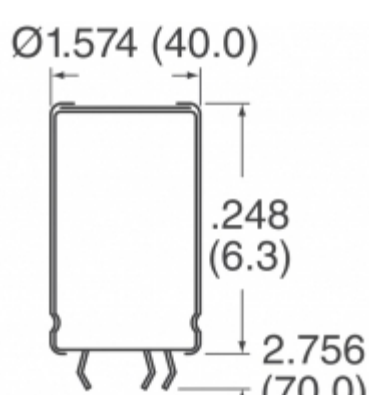

**Part Number:** MAL209616821E3  
**Manufacturer:** Electro-Films (EFI) / Vishay  
**Description:** CAP ALUM 820UF 20% 400V SNAP  
**Data sheet:** [096 PLL-4TSI \(MAL2096\) Series](#)  
[Aluminum Electrolytic Capacitors Guide](#)

**RoHS Status:** Lead free / RoHS Compliant  
**Ship From:** Hong Kong  
**Shipment Way:** DHL/Fedex/TNT/UPS/EMS

Images are for reference only.  
 See Product Specifications for product details.  
**Buy MAL209616821E3 with confidence from Component-World.HK, 1 Year Warranty**







[Request For Quotation](#)

**PRODUCT PARAMETER**

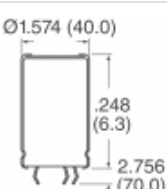
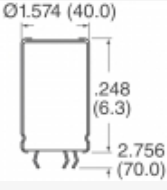
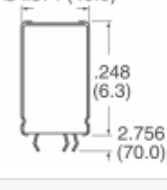
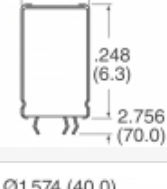
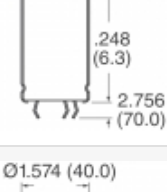
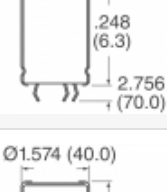
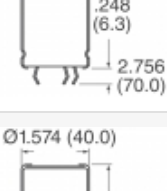
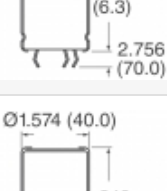
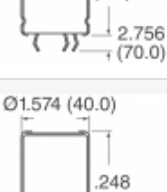
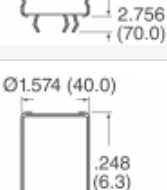
<b>Part Number</b>	MAL209616821E3	<b>Manufacturer</b>	<a href="#">Electro-Films (EFI) / Vishay</a>
<b>Description</b>	CAP ALUM 820UF 20% 400V SNAP	<b>Lead Free Status / RoHS Status</b>	Lead free / RoHS Compliant
<b>Quantity Available</b>	5999 pcs	<b>Data sheet</b>	<a href="#">096 PLL-4TSI (MAL2096) Series</a> <a href="#">Aluminum Electrolytic Capacitors Guide</a>
<b>Category</b>	<a href="#">Capacitors</a>	<b>Voltage - Rated</b>	400V
<b>Tolerance</b>	±20%	<b>Surface Mount Land Size</b>	-
<b>Size / Dimension</b>	1.378" Dia (35.00mm)	<b>Series</b>	096 PLL-4TSI
<b>Ripple Current @ Low Frequency</b>	4.4A @ 100Hz	<b>Ratings</b>	-
<b>Polarization</b>	Polar	<b>Packaging</b>	Tape & Box (TB)
<b>Package / Case</b>	Radial, Can - Snap-In - 4 Lead	<b>Operating Temperature</b>	-40°C ~ 85°C
<b>Mounting Type</b>	Through Hole	<b>Moisture Sensitivity Level (MSL)</b>	1 (Unlimited)
<b>Manufacturer Standard Lead Time</b>	13 Weeks	<b>Lifetime @ Temp.</b>	5000 Hrs @ 85°C
<b>Lead Spacing</b>	-	<b>Lead Free Status / RoHS Status</b>	Lead free / RoHS Compliant
<b>Impedance</b>	71 mOhms	<b>Height - Seated (Max)</b>	3.150" (80.00mm)
<b>ESR (Equivalent Series Resistance)</b>	180 mOhm @ 100Hz	<b>Detailed Description</b>	820µF 400V Aluminum Electrolytic Capacitors Radial, Can - Snap-In - 4 Lead 180 mOhm @ 100Hz 5000 Hrs @ 85°C
<b>Capacitance</b>	820µF	<b>Applications</b>	General Purpose

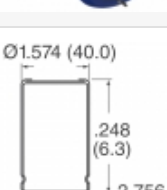
Component-World.com is a Reliable Stocking Distributor of Electronic Components. We specialize in all Electro-Films (EFI) / Vishay series electronic components. We have 5999 pieces of Electro-Films (EFI) / Vishay MAL209616821E3 in stock available now. Request a quote from electronics components distributor at Component-World.com, our sales team will contact you within 24 hours.  
 RFQ Email: info@Components-World.com

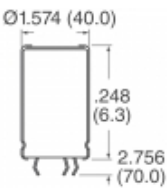
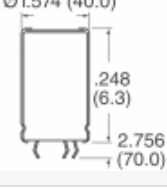
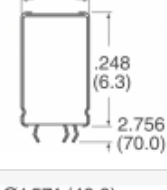
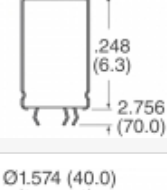
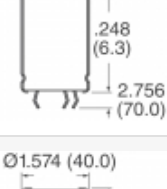
**RELATED PRODUCTS**

	<b>Part#:</b> MAL209614681E3 <b>Description:</b> CAP ALUM 680UF 20% 420V SNAP	<b>Manufacturers:</b> <a href="#">Electro-Films (EFI) / Vishay</a>	<a href="#">RFQ</a>
	<b>Part#:</b> MAL209616152E3 <b>Description:</b> CAP ALUM 1500UF 20% 400V SNAP	<b>Manufacturers:</b> <a href="#">Electro-Films (EFI) / Vishay</a>	<a href="#">RFQ</a>
	<b>Part#:</b> MAL209617102E3 <b>Description:</b> CAP ALUM 1000UF 20% 450V SNAP	<b>Manufacturers:</b> <a href="#">Electro-Films (EFI) / Vishay</a>	<a href="#">RFQ</a>
	<b>Part#:</b> MAL209617561E3 <b>Description:</b> CAP ALUM 560UF 20% 450V SNAP	<b>Manufacturers:</b> <a href="#">Electro-Films (EFI) / Vishay</a>	<a href="#">RFQ</a>
	<b>Part#:</b> MAL209618681E3 <b>Description:</b> CAP ALUM 680UF 20% 385V SNAP	<b>Manufacturers:</b> <a href="#">Electro-Films (EFI) / Vishay</a>	<a href="#">RFQ</a>
	<b>Part#:</b> MAL209617821E3 <b>Description:</b> CAP ALUM 820UF 20% 450V SNAP	<b>Manufacturers:</b> <a href="#">Electro-Films (EFI) / Vishay</a>	<a href="#">RFQ</a>
	<b>Part#:</b> MAL209618102E3 <b>Description:</b> CAP ALUM 1000UF 20% 385V SNAP	<b>Manufacturers:</b> <a href="#">Electro-Films (EFI) / Vishay</a>	<a href="#">RFQ</a>
	<b>Part#:</b> MAL209615122E3 <b>Description:</b> CAP ALUM 1200UF 20% 350V SNAP	<b>Manufacturers:</b> <a href="#">Electro-Films (EFI) / Vishay</a>	<a href="#">RFQ</a>
	<b>Part#:</b> MAL209618821E3 <b>Description:</b> CAP ALUM 820UF 20% 385V SNAP	<b>Manufacturers:</b> <a href="#">Electro-Films (EFI) / Vishay</a>	<a href="#">RFQ</a>
	<b>Part#:</b> MAL209618122E3 <b>Description:</b> CAP ALUM 1200UF 20% 385V SNAP	<b>Manufacturers:</b> <a href="#">Electro-Films (EFI) / Vishay</a>	<a href="#">RFQ</a>
	<b>Part#:</b> MAL209615102E3 <b>Description:</b> CAP ALUM 1000UF 20% 350V SNAP	<b>Manufacturers:</b> <a href="#">Electro-Films (EFI) / Vishay</a>	<a href="#">RFQ</a>
	<b>Part#:</b> MAL209619471E3 <b>Description:</b> CAP ALUM 470UF 20% 500V SNAP	<b>Manufacturers:</b> <a href="#">Electro-Films (EFI) / Vishay</a>	<a href="#">RFQ</a>
	<b>Part#:</b> MAL209614821E3 <b>Description:</b> CAP ALUM 820UF 20% 420V SNAP	<b>Manufacturers:</b> <a href="#">Electro-Films (EFI) / Vishay</a>	<a href="#">RFQ</a>
	<b>Part#:</b> MAL209619391E3 <b>Description:</b> CAP ALUM 390UF 20% 500V SNAP	<b>Manufacturers:</b> <a href="#">Electro-Films (EFI) / Vishay</a>	<a href="#">RFQ</a>
	<b>Part#:</b> MAL209616681E3 <b>Description:</b> CAP ALUM 680UF 20% 400V SNAP	<b>Manufacturers:</b> <a href="#">Electro-Films (EFI) / Vishay</a>	<a href="#">RFQ</a>
	<b>Part#:</b> MAL209616122E3 <b>Description:</b> CAP ALUM 1200UF 20% 400V SNAP	<b>Manufacturers:</b> <a href="#">Electro-Films (EFI) / Vishay</a>	<a href="#">RFQ</a>
	<b>Part#:</b> MAL209615821E3 <b>Description:</b> CAP ALUM 820UF 20% 350V SNAP	<b>Manufacturers:</b> <a href="#">Electro-Films (EFI) / Vishay</a>	<a href="#">RFQ</a>
	<b>Part#:</b> MAL209617681E3 <b>Description:</b> CAP ALUM 680UF 20% 450V SNAP	<b>Manufacturers:</b> <a href="#">Electro-Films (EFI) / Vishay</a>	<a href="#">RFQ</a>
	<b>Part#:</b> MAL209615152E3 <b>Description:</b> CAP ALUM 1500UF 20% 350V SNAP	<b>Manufacturers:</b> <a href="#">Electro-Films (EFI) / Vishay</a>	<a href="#">RFQ</a>
	<b>Part#:</b> MAL209616102E3 <b>Description:</b> CAP ALUM 1000UF 20% 400V SNAP	<b>Manufacturers:</b> <a href="#">Electro-Films (EFI) / Vishay</a>	<a href="#">RFQ</a>

**Related keywords for MAL209616821E3**

Electro-Films (EFI) / Vishay MAL209616821E3	MAL209616821E3 distributor	MAL209616821E3 supplier	MAL209616821E3 price
MAL209616821E3 download datasheet	MAL209616821E3 datasheet	MAL209616821E3 stock	buy MAL209616821E3
Electro-Films (EFI) / Vishay MAL209616821E3	Electro-Films (EFI) / Vishay MAL209616821E3	Vishay Electro-Films MAL209616821E3	Phoenix Passive Components / Vishay MAL209616821E3